

# TYXIA 4850

Micromodule récepteur sans fil  
sortie alimentée par la charge

Quelle position du sélecteur  
pour quelles applications ?



## POSITION 1



Variation de l'éclairage  
par commande Radio ou locale

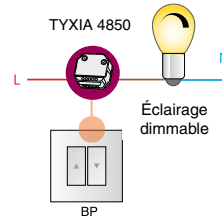

et/ou

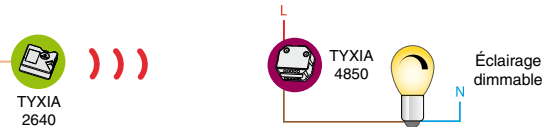

et/ou

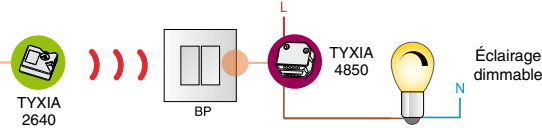

## POSITION 2



Temporiser un éclairage par commande  
radio ou détecteur de présence filaire...

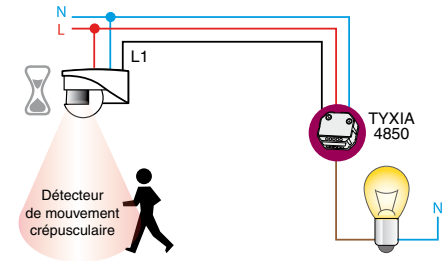

et/ou

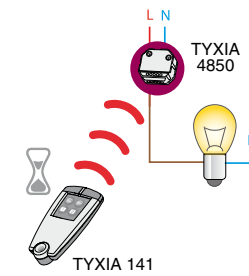

et/ou

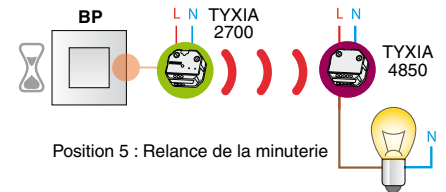

Et/ou



Permettre une marche forcée  
par interrupteur filaire

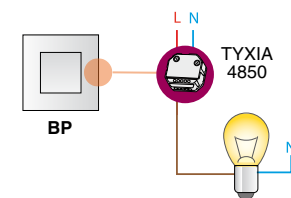

POSITION 3



Temporiser un éclairage par détecteur de présence filaire...

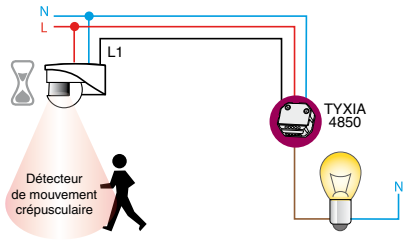

Et/ou



Permettre une marche forcée par commande radio ou interrupteur filaire

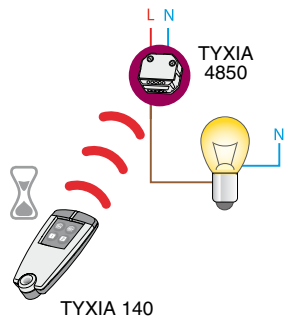

et/ou

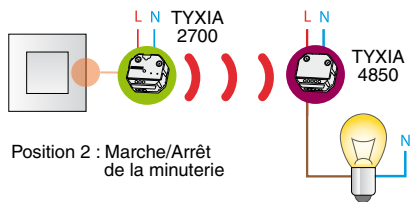

et/ou

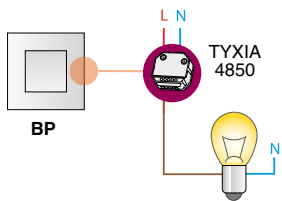

POSITION 4



Temporiser un éclairage dans un lieu de passage à partir de tout type de commande

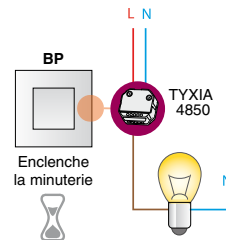

et/ou

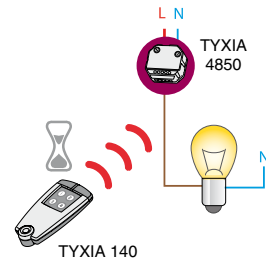

et/ou

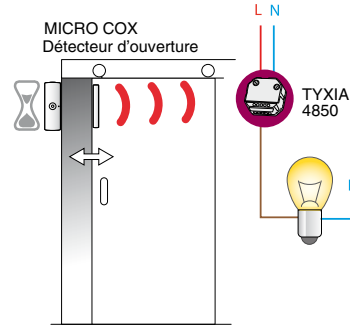

et/ou

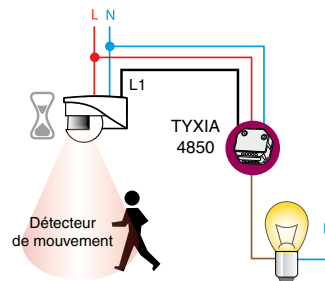

POSITION 5

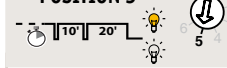

Temporiser un éclairage avec préavis d'extinction (ex. : cage d'escalier, hall d'établissement recevant du public)

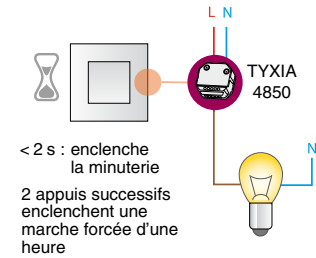

et/ou

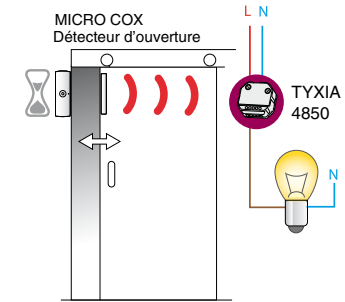

et/ou

